



RB10-PC

Voltage: 12.8V | Capacity: 10 Ah | Energy: 128 Wh

LITHIUM IRON PHOSPHATE BATTERY **LiFePO4**

ELECTRICAL SPECIFICATIONS

Nominal Voltage	12.8 V
Nominal Capacity	10 Ah
Capacity @ 25A	24 min
Resistance	30 mΩ
Efficiency	99%
Self Discharge	<3% per Month
Maximum Modules in Series	6

DISCHARGE SPECIFICATIONS

Maximum Continuous Discharge Current	50 A
Peak Discharge Current	70 A (<3 s)
BMS Discharge Current Cut-Off	275 A (±25 A)
Recommended Low Voltage Disconnect	11 V
BMS Discharge Voltage Cut-Off	8 V
Reconnect Voltage	9.2 V
Short Circuit Protection	200-800 μs

TEMPERATURE SPECIFICATIONS

Discharge Temperature	-4 to 140 °F (-20 to 60 °C)
Charge Temperature*	-4 to 113 °F (-20 to 45 °C)
Storage Temperature	-4 to 140 °F (-20 to 60 °C)
PCM High Temperature Cut-Off	176 °F (80 °C)

*Refer to charge currents below 32°F (0°C)

MECHANICAL SPECIFICATIONS

Dimensions (L x W x H)	7.1 x 3.0 x 6.7" 181 x 76 x 169 mm
Weight	4.4 lbs (2 kg)
Terminal Type	Charge: M4 x 0.7 Discharge: M6 x 1.0
Case Material	ABS
Enclosure Protection	IP66
Cell Type - Chemistry	Cylindrical - LiFePO ₄

CHARGE SPECIFICATIONS

Recommended Charge Current	0.5 A - 5 A
Maximum Charge Current	10 A
PCM Charge Current Cut-Off	275 A (±25 A)
Charge Current 14 to 32 °F (-10 to 0 °C)	≤0.1 C
Charge Current -4 to 14 °F (-20 to -10 °C)	≤0.05 C
Recommended Charge Voltage	14.2 V - 14.6 V
PCM Charge Voltage Cut-Off	15.6 V (3.9 ±0.025 vpc) (1.0 ±0.5 s)
Reconnect Voltage	15.2 V (3.8 ±0.05 vpc)
Balancing Voltage	14.4 V

COMPLIANCE SPECIFICATIONS

Certifications	UN38.3 & CE (battery) UL1642 (cells) (File# MH62098) IEC62133 (cells)
Shipping Classification	UN 3480, CLASS 9

DIMENSIONAL SPECIFICATIONS

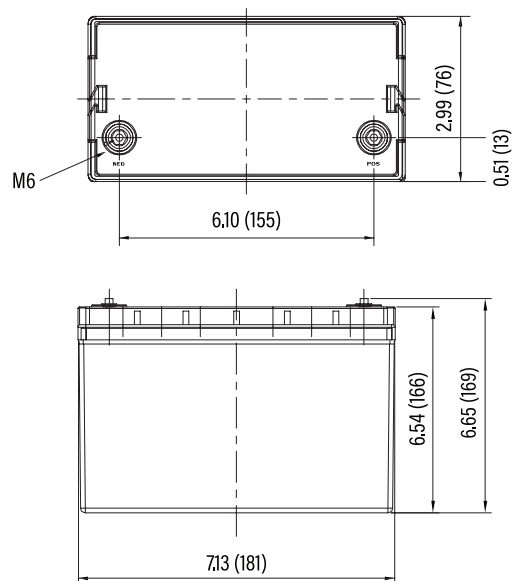



RB10-PC

Voltage: 12.8V | Capacity: 10 Ah | Energy: 128 Wh

LITHIUM IRON PHOSPHATE BATTERY **LiFePO4**

PERFORMANCE CHARACTERISTICS

DISCHARGE VOLTAGE CHARACTERISTICS at VARIOUS RATES
25°C (77°F)

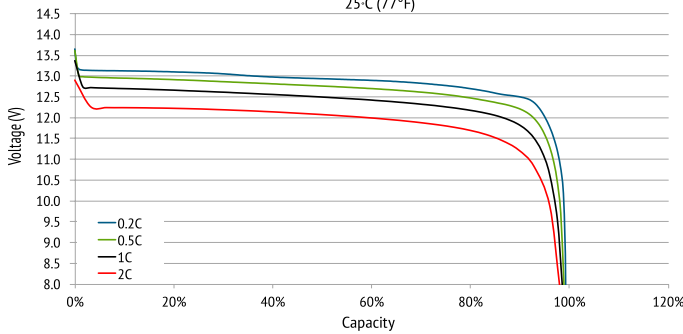

DISCHARGE VOLTAGE CHARACTERISTICS at VARIOUS TEMPERATURES
DISCHARGE 1C

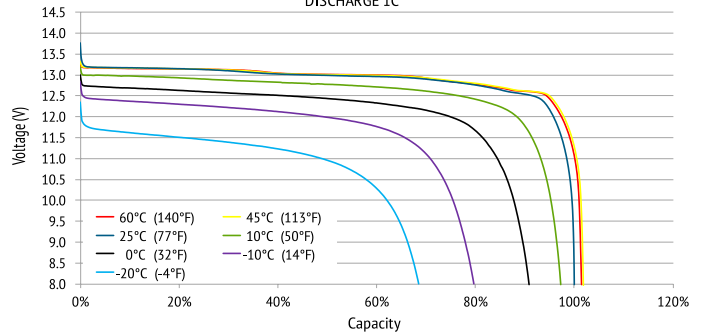

CHARGE VOLTAGE CHARACTERISTICS at VARIOUS TEMPERATURES
CHARGE 0.2C

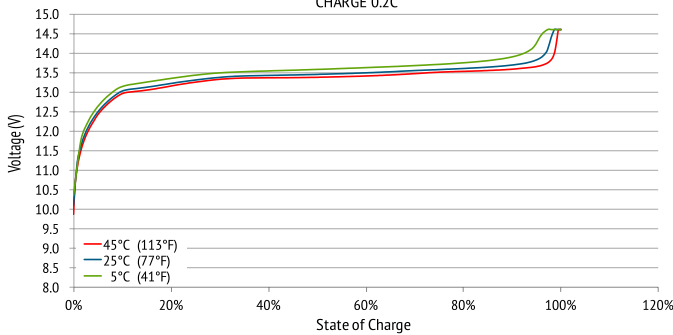

CHARGE VOLTAGE and STATE OF CHARGE (SOC)
CHARGE 0.2C @ 25°C (77°F)

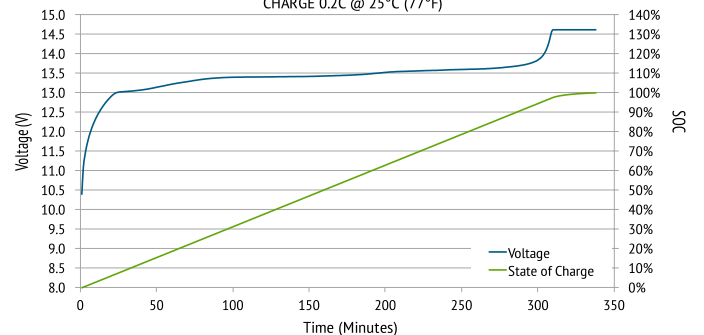

CYCLE LIFE vs. DEPTH OF DISCHARGE (DOD)
DISCHARGE 0.5C/CHARGE 0.5C @ 25°C (77°F)

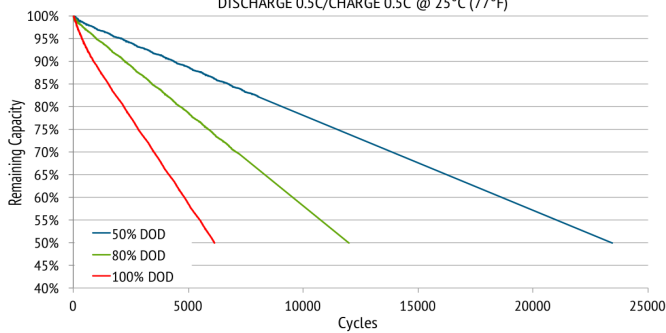

CAPACITY of RELiON LiFePO4 vs. LEAD ACID
at VARIOUS RATES OF DISCHARGE

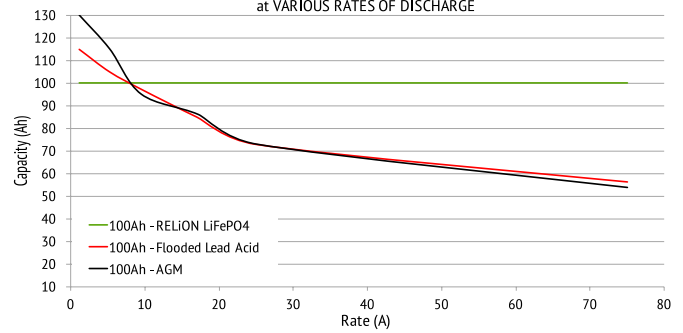

reionbattery.com

+1.803.547.7288 • TOLL FREE: (855) 931-2466 | 1433 Dave Lyle Blvd • Rock Hill, SC 29730

UN38.3

