

RELi³ON[®]

INSIGHT SERIES MANUAL



insight
SERIES[®]

TABLE OF CONTENTS

1	Safety Instructions	3			
1.1	Warnings And Symbols	3			
1.2	Safety Warnings	3			
1.3	Safety Guidelines	4			
2	General Information	5			
2.1	Liability	5			
2.2	Warranty Registration	5			
2.3	Life Cycles And C-Rate	5			
2.4	Disclaimer	5			
2.5	Identification Label	6			
2.6	Correct Disposal Of This Product	6			
3	Introduction	6			
3.1	Scope	6			
3.2	Abbreviations Used In The Manual	6			
4	Product Specifications	7			
4.1	General Specifications	7			
4.2	Electrical Specifications	7			
4.2.1	Charging Specifications	7			
4.2.2	Discharging Specifications	8			
4.3	Mechanical Specifications	9			
4.3.1	Mechanical Drawing	9			
4.4	Environmental Specifications	9			
5	Battery Installation Reccomandations	10			
5.1	Parallel Connections Reference Scheme	10			
5.2	Battery Orientation	11			
6	Callout	11			
7	Battery Interface	11			
7.1	Power Button	11			
7.2	LEDs	11			
7.3	Battery Status Descriptions	12			
7.4	Power Button Functions	12			
7.5	LED Function	12			
7.5.1	Battery Status	12			
7.5.2	SOC Status (Initiate With A Single Tap Of The Power Button)	13			
7.5.3	Protection/Error Indicators	13			
8	Battery Mode Operation Details	13			
8.1	Off Mode	13			
8.2	On Mode	13			
8.3	Sleep Mode	13			
8.3.1	Pulse Recovery Operation (PRO) During Sleep Mode	14			
8.4	Under Voltage Protection (UVP) Mode	14			
9	BMS Protection Details	14			
9.1	Under Voltage Protection (UVP)	14			
9.2	Over Voltage Protection (OVP)	14			
9.3	Under Temperature Protection (UTP)	14			
9.4	Over Temperature Protection (OTP)	14			
9.5	Over Current Protection (OCP)	15			
9.6	Short Circuit Protection (SCP)	15			
10	CANbus Communication	15			
10.1	CAN Battery Connectors: M8-5P	15			
10.2	Communication Hardware	15			
10.3	CANbus Details	16			
10.4	Broadcast Data	16			
11	Charging Guidelines	16			
11.1	Charger Inspection	16			
11.2	Charge Temperature	16			
11.3	Prior To Charge	16			
11.4	During Charge	17			
11.5	Charge Completion	17			
12	Battery Indicator	17			
13	Battery Storage	18			
14	Recycling	18			
15	RELiON and Navico Group Technical Support	18			

1. SAFETY INSTRUCTIONS

IMPORTANT SAFETY INSTRUCTIONS SAVE THESE INSTRUCTIONS FOR FUTURE REFERENCE

1.1. Warnings and symbols

Safety instructions and warnings are marked in this manual by the following pictograms:

 **CAUTION!** Special information, commands, and prohibitions in order to prevent damage.

 **WARNING!** It refers to possible injury to the user or installer or significant material damage to the RELiON InSight batteries if the installer / user does not (carefully) follow the stated procedures.

 **ADVICE** It is a general suggestion which can improve performance or mitigate risk of not dangerous events

1.2. Safety warnings

 **WARNING!**

The battery contains hazardous materials that are stored safely during normal use. Do not crush, open or drop the battery housing. Do not touch or ingest any of the released materials or inhale released gasses when accidental leakage of the battery occurs. Should skin contact, eye contact or inhalation nevertheless occur, take the necessary first aid measures immediately. Refer to the LiFePO4 Safety Document, which is available on www.relionbattery.com.

 **WARNING!**

Avoid short circuiting batteries as this may result in fire, explosion, electric shock or release of toxic gas. Use insulated tools only and keep metal objects away from the battery. Do not wear watches, bracelets, necklaces or other metal objects when working on the battery. In case of fire, take the necessary firefighting measures immediately. Refer to the LiFePO4 Safety Document, which is available on www.relionbattery.com.

 **WARNING!**

Short circuits, too deep discharges and too high charge currents will damage the battery and may result in fire, explosion, electric shock or release of toxic gas.

Never charge a battery:

- after it was discharged below the Permanent Off voltage.
- when the battery is damaged.
- when the battery was over-charged.

If in doubt, contact your RELiON dealer.

 **CAUTION!**

When transported, make sure that:

- the battery is in its original package or equivalent UN38.3.
- the battery is in upright position.
- soft slings are used to avoid damage.
- the battery is only lifted at the handles reference.
- the battery is handled with care.

 **ADVICE**

The voltage range ([11.6-14.5]V; [23.0-28]V and [43.0-57]V) is larger than you may expect from other battery types such as lead-acid batteries. Be aware that these voltages could exceed the permitted voltages of the connected load(s).

⚠ WARNING REGARDING LIFE SUPPORT APPLICATIONS

RELiON products are not designed to be used as components of medical equipment, unless negotiated in the form of a written agreement between customer and/or manufacturer and NAVICO GROUP. Such agreement will require the equipment manufacturer either to contract additional reliability testing of the RELiON parts and/or to commit to undertake such testing as a part of the manufacturing process. Furthermore, the manufacturer must agree to indemnify and not hold NAVICO GROUP responsible for any claims arising from the use of the RELiON parts in the life support equipment.

1.3. Safety guidelines

Lithium Iron Phosphate (LiFePO₄) batteries are an inherently safe chemistry. Please reference RELiON's LiFePO₄ Safety Document, which is available on www.relionbattery.com, for more details. However, as with any electronics, safety measures should always be taken. Please adhere to the instructions within this manual for safe handling and operation.

- ✓ Use the RELiON InSight batteries following the instructions and specifications stated in this manual.
- ✓ Non-compliance with operating instructions, repairs made with other than original parts, or repairs made without authorization render the warranty.
- ✓ Connections and safety features must always comply with all local rules and regulations.
- ✓ Use connecting cables with an appropriate size and protection devices.
- ✓ Never use the RELiON InSight batteries in situations where there is danger of gas or dust explosion or potentially flammable products!
- ✓ Only use the RELiON InSight batteries in a technical correct condition.
- ✓ Only use the RELiON InSight batteries in a well-ventilated area and protect the connectors from moisture and dust.
- ✓ Switch off all charging systems and disconnect the RELiON InSight batteries from the electrical installation during maintenance and/or repair activities.
- ✓ Always wear protective gear when handling batteries
- ✓ Use a wrench with a rubber coated handle for operations.
- ✓ Do not place any objects on top of batteries.
- ✓ Regularly check that all cables are in good condition.
- ✓ Regularly verify that all cable connections are properly tightened.
- ✓ Move batteries using lifting strap brackets.
- ✓ Do not smoke and bring free flame sources near batteries.
- ✓ Do not install batteries in a zero-clearance compartment, overheating may result.
- ✓ Keep any flammable/combustible material (e.g., paper, cloth, plastic, etc.) that may be ignited by heat, sparks, or flames at a minimum distance of two feet away from the batteries.
- ✓ Battery compartment and any material within two feet should be non-flammable.
- ✓ Keep sparks, flames and metal objects away from batteries.
- ✓ Have RELiON's LiFePO₄ Safety Data Sheet (SDS) on premises.
- ✓ Have a Class ABC fire extinguisher on the premises.

2. GENERAL INFORMATION

2.1. Liability

NAVICO GROUP cannot be held liable for:

- Consequential damage resulting from the misuse of the RELiON InSight batteries.
- Possible errors in the included manual and the consequences of these.
- Use that is inconsistent with the purpose of the RELiON InSight batteries.

2.2. Warranty registration

The RELiON product warranty covers the RELiON InSight batteries as per the terms in the warranty conditions, on the condition that the product is installed and used according to the instructions in this manual. Installation or use that does not comply with these instructions may result in under performance, damage or failure of the product and may void this warranty. The warranty is limited to the cost of repair and/or replacement of the product. Costs of labor or shipping are not covered by this warranty. For further terms and condition please refer to RELiON Batteries Warranty terms and conditions.

We recommend you protect your investment and register your warranty at www.relionbattery.com/warranty-registration.

2.3. Life cycles and C-rate

The C-rate indicates how fast a battery can be (dis)charged. The C-rate of a battery is commonly expressed in Amper-hours(Ah) and the related charge/discharge capability is expressed in numbers that look like 1C, 2C, or C/2. A C-rate of C/2 is also known as 0.5C. A fully charged battery rated at C = 100Ah, provides 100A for one hour. The same battery discharging at C/2 provides 50A for two hours. At 2C it provides 200A for 30 minutes. Charge and discharge C-rates can have an impact on the number of life cycles. As long as the discharge current is within the maximum allowed discharge current of the product, the RELiON InSight batteries provide 3500 cycles at an ambient temperature of 25°C [77°F] and a Depth of Discharge (DoD) set to 80%.

 To reach the specified number of cycles, we advise a maximum charge rate of C/2 and a discharge rate of 1C (1.5C for the 48V models). This corresponds to the following values:

Ambient Temperature [30-95] °F or [15-25] °C	12V120-1-GC2 12V120-1-GC2-LT	24V060-GC2 24V060-1-GC2-LT	48V030-GC2 48V030-GC2-LT
Recommended charge current	≤ 60 A	≤ 30 A	≤ 15 A
Recommended discharge current	≤ 120 A	≤ 60 A	≤ 45 A

2.4. Disclaimer

RELiON is a brand of Navico Group, the products are subject to continual development and improvement. Therefore, additions or modifications to the products may cause changes to the technical data and functional specifications. No rights can be derived from this document. Please consult our online Terms & Conditions of Sale. It is recommended to stay up to date with the latest version of the document with the online reference at www.relionbattery.com.

2.5. Identification label

The identification label is located on the top side of the RELiON InSight batteries. Technical information required for service and maintenance (part number, serial number) can be derived from the identification label.

CAUTION!

Never remove the identification label.
This will void the warranty.

2.6. Correct disposal of this product



This product is designed and manufactured with high quality materials and components, which can be recycled and reused. Act according to your local rules and do not dispose of your old products with your normal household waste. The correct disposal of your old product will help prevent potential negative consequences to the environment and human health.

3. INTRODUCTION

RELiON's InSight Series[®] batteries are the first scalable LiFePO₄ drop-in replacement batteries, which comes in an industry standard, GC2 size.

3.1. Scope

This document applies to the following models:

- 12V120-1-GC2
- 12V120-1-GC2-LT
- 24V060-GC2
- 24V060-1-GC2-LT
- 48V030-GC2
- 48V030-GC2-LT

3.2. Abbreviations Used In The Manual

- | | |
|--|---|
| <ul style="list-style-type: none"> ▪ State of Charge (SOC) ▪ Over Voltage Protection (OVP) ▪ Under Voltage Protection (UVP) ▪ Over Temperature Protection (OTP) ▪ Under Temperature Protection (UTP) ▪ Over Current Protection (OCP) ▪ Short Circuit Protection (SCP) | <ul style="list-style-type: none"> ▪ Light Emitting Diode (LED) ▪ Pulse Recovery Operation (PRO) ▪ Controller Area Network bus (CANbus) ▪ Battery Display Indicator (BDI) ▪ Low Temperature (LT) |
|--|---|

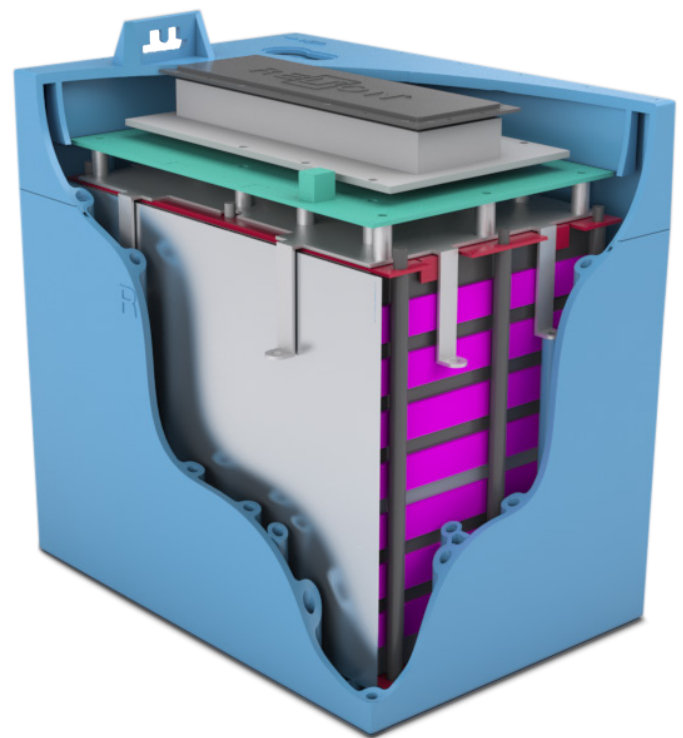

4. PRODUCT SPECIFICATIONS

4.1. General Specifications

GENERAL SPECIFICATIONS			
Model	48V030-GC2 48V030-GC2-LT	24V060-GC2 24V060-1-GC2-LT	12V120-1-GC2 12V120-1-GC2-LT
Nominal Voltage	51.2V	25.6V	12.8V
Cell Chemistry	LiFePO ₄	LiFePO ₄	LiFePO ₄
Cell Type	Prismatic	Prismatic	Prismatic
Ampere-hour Capacity	30Ah	60Ah	120Ah
Watt-hour Capacity	1.536kWh	1.536kWh	1.536kWh
Charge Efficiency	99%	99%	99%
Impedance (50% SOC, 1kHz)	<150mΩ	<150mΩ	<100mΩ
Cycles @ 80% DOD <i>Refer to warranty terms for Cycle Life performance conditions</i>	>3500	>3500	>3500

4.2. Electrical Specifications

4.2.1. Charging Specifications

CHARGE SPECIFICATIONS			
Model	48V030-GC2 48V030-GC2-LT	24V060-GC2 24V060-1-GC2-LT	12V120-1-GC2 12V120-1-GC2-LT
Recommended Charge Current (single battery)	≤15A (0.5C)	≤30A (0.5C)	≤60A (0.5)
Continuous Charge Current	≤30A (1C)	≤60A (1C)	≤120A (1C)
Disconnect Charge Current ¹ (BMS will disconnect if exceeded)	I _{batt} >30A, 5s I _{batt} >50A, 0.5s	I _{batt} >60A, 5s I _{batt} >100A, 0.5s	I _{batt} >120A, 5s I _{batt} >200A, 0.5s
Peak Charge Voltage	57V	28.5V	14.3V
Float Voltage	54V	27V	13.5V
Over Voltage Protection	3.65V/cell 4s (58.4V)	3.65V/cell 4s (29.2V)	3.65V/cell 4s (14.6V)
Over Voltage Reconnect	3.4V/cell (54.4V)	3.4V/cell (27.2V)	3.4V/cell (13.6V)

¹Self-reset protection, refer to paragraph 9.5.

4.2.2. Discharging Specifications

DISCHARGE SPECIFICATIONS			
Model	48V030-GC2 48V030-GC2-LT	24V060-GC2 24V060-1-GC2-LT	12V120-1-GC2 12V120-1-GC2-LT
Recommended Continuous Discharge Current	45A (1.5C)	60A (1C)	120A (1C)
Maximum Continuous Discharge Current	100A	100A	120A
Peak Over Current	100A<I _{batt} <120A, 10s 120A<I _{batt} <180A, 5s 180A<I _{batt} <250A, 1s I _{batt} >250A, 0.5s	100A<I _{batt} <200A, 50s 200A<I _{batt} <360A, 5s 360A<I _{batt} <500A, 1s I _{batt} >500A, 0.5s	120A<I _{batt} <300A, 10s 300A<I _{batt} <360A, 2s 360A<I _{batt} <500A, 1s I _{batt} >500A, 0.5s
Short Circuit Protection	>350A	>500A	>500A
Discharge Cut Off Pulse Recovery Operation	Automatically under 2.9V/cell (46.4V)	Activated under 2.9V/cell (23.2V)	Activated under 2.9V/cell (11.6V)
Low Voltage Protection	2.8V/cell (44.8V)	2.8V/cell (22.4V)	2.8V/cell (11.2V)
Permanent Off Voltage*	1.8V/cell (28.8V)	1.8V/cell (14.4V)	1.8V/cell (7.2V)

⚠ CAUTION: In case of long storage time with a minimum State of Charge the battery might reach a permanent off state which cannot be recovered with a charging procedure. If this condition is met, contact technical support as per paragraph RELiON and NAVICO GROUP Technical Support.

4.3. Mechanical Specifications

MECHANICAL SPECIFICATIONS			
Model	48V030-GC2 48V030-GC2-LT	24V060-GC2 24V060-1-GC2-LT	12V120-1-GC2 12V120-1-GC2-LT
BCI Size	GC2		
Dimensions (L x W x H)	260 x 180 x 276 mm (10.2 x 7.1 x 10.9 in)		
Weight	15.6 kg (34.4 lbs)		
Case Material	ABS		
Stud Terminal	M8 X 1.25 - 20		
Insert Terminal	M8 X 1.25 - 20		
Closing Torque	9-10 Nm (79.7-88.5 in-lbs)		
Handles	Molded		
Ingress Protection Marking	IP67		
Case Flame Rating	UL94 V-0		

4.3.1. Mechanical Drawing

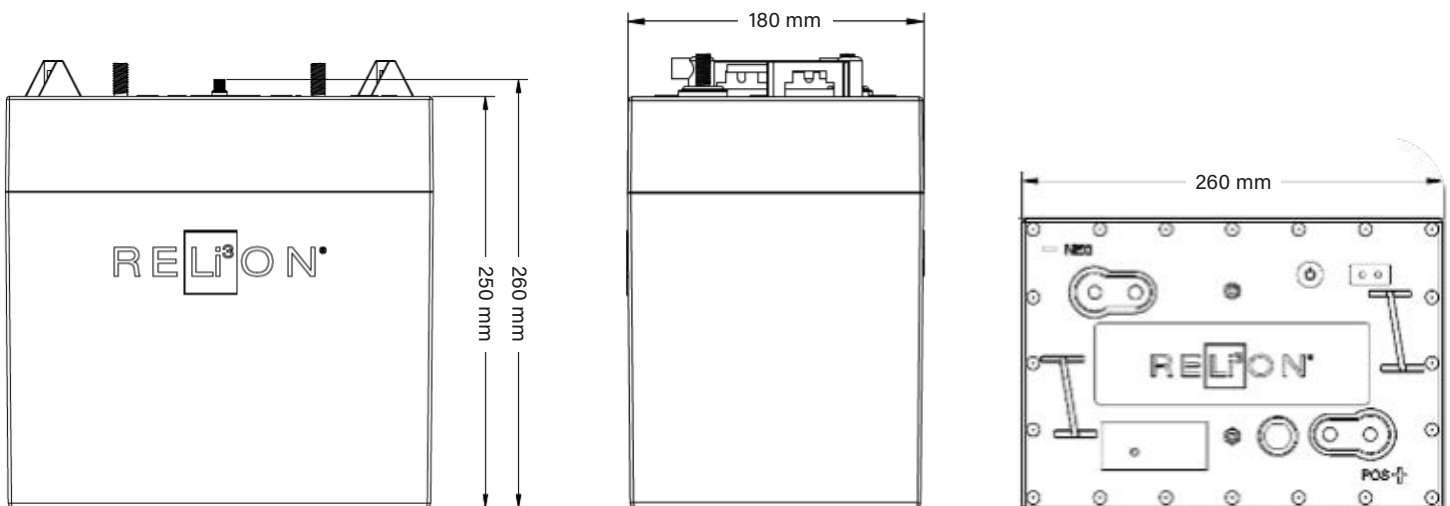

4.4. Environmental Specifications

ENVIRONMENTAL SPECIFICATIONS	
Charge Under Temperature	0°C (32°F) for 2s Self-reset function.
Charge Over Temperature	55°C (131°F) for 2s Self-reset function.
Discharge Under Temperature	-20°C (-4°F) for 2s Self-reset function.
Discharge Over Temperature	55°C (131°F) for 2s Self-reset function.
Operating Humidity Range	10% to 95% RH non-condensing
Optimal Storage Temperature	10°C to 35°C (50°F to 95°F)
Optimal Storage Humidity	15% to 90% RH

*Low Temperature (LT) version of the product allows a charging operation at -20°C (-4°F).

5. BATTERY INSTALLATION RECOMMENDATIONS

To ensure proper operation of the battery (for single-battery or multiple-battery installations), follow the steps below:

- ✓ **CAUTION:** InSight batteries can only be used in parallel (not series). Up to 10 batteries may be connected.
- ✓ Position the battery according to the permitted orientation as per section 5.1.1
- ✓ Select proper wire gauge for your applications electrical current (A) demands.
- ✓ On new installations it is recommended that new battery cables be used.
- ✓ Perform a general cleaning of the devices and remove possible oxidation layers from the terminals.
- ✓ Ensure that all battery cables are equal in length to avoid battery imbalances.
- ✓ All cables should terminate at bus bars with respect to their polarity.
- ✓ Use appropriate protective devices against short circuit and overcurrent to protect cables such as fuses or circuit breakers.
- ✓ Torque the battery terminals appropriately as listed in Section 5.3 Mechanical Specifications.
- ✓ Connect the provided Controller Area Network bus (CANbus) cables as shown in Section 10
- ✓ Turn batteries ON. See the table in Section 8.4.
- ✓ Charge the batteries to 100% State of Charge (SOC) prior to use.
- ✓ **CAUTION:** Verify all the connected electric devices are compatible to function within the range of voltage supplied by the batteries before activating the batteries.

5.1. Parallel Connections Reference Scheme

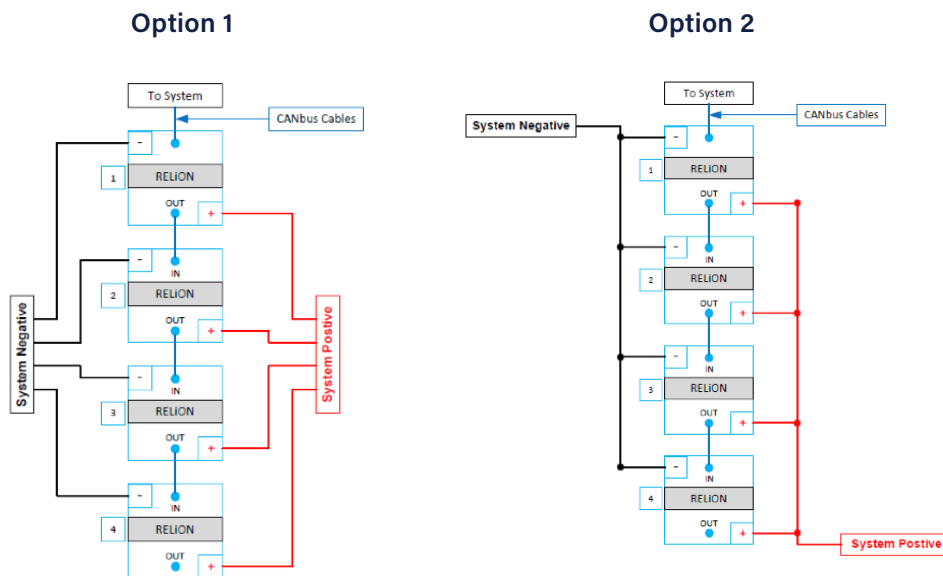

5.2 Battery Orientation

The best way to install the battery is upright as the bottom of the case is flat. The battery can be placed in the following orientations:

- Upright
- Short sides – either side
- Long side – only with positive side up

⚠ CAUTION:

- DO NOT INSTALL the battery on the long side with the negative side up as this can put stress on the internal connections causing damage that may result in battery failure.
- DO NOT INSTALL batteries in a zero-clearance compartment, overheating may result. Always leave at least 1 cm (3/8") of space around all sides and top of battery.
- Keep any flammable/combustible material (e.g., paper, cloth, plastic, etc.) that may be ignited by heat, sparks, or flames at a minimum distance of two feet away from the batteries.
- Battery compartment and any material within two feet should be noncombustible.

6. CALLOUT



1a. Negative Pole
Dual M8 Terminals
(insert & stud)

1b. Positive Pole
Dual M8 Terminals
(insert & stud)

2. CANbus Input

3. CANbus Output

4. Power Button

5. SOC/Status LEDs

6. Heatsink

7. Vent

8. GC2 Standard
Handles

9. Battery Label

7. BATTERY INTERFACE

7.1. Power Button

The battery has a button located next to the LED display that is used to:

- Turn the battery ON/OFF/RESET
- Request the battery SOC

7.2. LEDs

The battery has two tri-colored LED lights on the cover (green, yellow, and red) that are used to communicate:

- Battery Status
- Battery SOC
- Battery Protection/Error Status

7.3. Battery Status Descriptions

MODE	DESCRIPTION
OFF	Battery is OFF
ON (Active)	Battery is ON and being charged/discharged
ON (Standby)	Battery is ON and Idle
SLEEP	Battery is cycling ON/OFF intermittently
PROTECTION	BMS has disconnected voltage/current from terminals

7.4. Power Button Functions

ACTION	OPERATION	REMARKS
Power ON	<i>Press and hold</i> button for 5s until: <ul style="list-style-type: none"> ▪ LED1 Flashes Green ▪ Then release button 	Battery will turn ON
Display SOC	<i>Tap</i> button once	LED displays for 6 sec. See section 10: SOC Status
Power OFF	<i>Tap, release, then press and hold</i> button for 6s until: <ul style="list-style-type: none"> ▪ LED1 Solid Red ▪ LED2 Solid Red ▪ Then release button 	Battery will turn OFF
Reset BMS	<i>Tap, Press and hold</i> button for >2s until: <ul style="list-style-type: none"> ▪ LED1 is Solid Red ▪ LED2 is Solid Green ▪ Then release button 	<ul style="list-style-type: none"> ▪ BMS program restart ▪ SOC level re-calculates ▪ Pack input/output close and open again
Wake Up from Sleep	<i>Tap</i> button twice	Initiates 1 min. charge pickup window
Wake Up from UVP	<i>Tap</i> button twice	Initiates 1 min. charge pickup window

7.5. LED Function

7.5.1. Battery Status

MODE	LED 1	LED 2
OFF	Off	Off
ON (Active)	Flashing Green (every 5 sec.)	Off
ON (Standby)	Flashing Green (every 5 sec.)	Off
Charging	Off	Flashing Green (every 2 sec.)

7.5.2. SOC Status (Initiate With A Single Tap Of The Power Button)

SOC	LED 1	LED 2
95% - 100%	Solid Green	Solid Green
75% - 95%	Solid Green	Flashing Green (every ½ sec.)
50% - 75%	Solid Green	Solid Yellow
30% - 50%	Solid Green	Flashing Yellow (every ½ sec.)
10% - 30%	Solid Green	Solid Red
0 - 10%	Solid Green	Flashing Red (every ½ sec.)

7.5.3. Protection/Error Indicators

MODE	LED 1	LED 2
Under Voltage Protection	Flashing Red (every 5 sec.)	Off
Over Discharge Current Protection	Solid Green	Solid Yellow
Temperature Protection	Flashing Green (every sec.)	Flashing Red (every sec.)

8. BATTERY MODE OPERATION DETAILS

8.1. OFF Mode

The battery ships in the OFF mode. There is no LED activity and voltage is not present at the terminals. To turn the battery OFF: Tap the button once, release, then press the button again holding for 6 seconds until you see both LEDs display solid red lights then release the button. This action will turn off both LEDs.

8.2. ON Mode

To turn the battery on press button for 5 seconds. LED1 will flash green every 5 seconds.

- **ON (Active)** - The battery is in ACTIVE mode only while being charged or discharged. The minimum charge current for active mode is 0.5A (2s). The minimum discharge current for active mode is 0.8A (1s).
- **ON (Standby)** - STANDBY mode is any time the battery is ON and not being discharged or charged. When a battery is in STANDBY mode, voltage is present at the terminals. If it is charged or discharged during STANDBY mode it will return to ACTIVE mode. If a battery is sitting in STANDBY mode continuously for more than 72 hours (24 hours for 12V battery) it will enter SLEEP mode.

8.3. SLEEP Mode

The battery will go into SLEEP mode if it is in STANDBY mode for more than 72 hours (24 hours for 12V battery) without being discharged or charged. The LEDs will not be illuminated.

The battery will go into a Pulse Recovery Operation (PRO) while in SLEEP mode.

8.3.1. Pulse Recovery Operation (PRO) During SLEEP Mode

The purpose of Pulse Recovery Operation is to place the battery in a low power state to preserve its energy. The battery will cycle between the OFF and ON (Standby) modes as follows:

The battery will turn ON (Standby) periodically and the LED1 will flash green every 0.5 seconds when the battery is ON.

The PRO mode will be automatically interrupted by connecting a compatible battery charger to the battery. During the ON (Standby) phase in Pulse Recovery Operation the battery will return to ON (Active) mode once the charging process is started.

The ON phase (PRO) can also be triggered manually as per 7.1. A compatible battery charger must then be connected before the battery turns OFF again.

8.4. Under Voltage Protection (UVP) Mode

If any of the battery cells voltage is reduced to less than 2.8V as defined in section 4.2.2, the battery will go into UVP mode. LED1 will flash RED every five (5) seconds.

The battery will then move to OFF MODE and charging could be resumed by pushing the Power Button.

9. BMS PROTECTION DETAILS

The Battery Management System of the RELiON InSight batteries has been developed to guarantee safe operations within the maximum performance of the batteries and to optimize the lifespan. Specifically, the most relevant protection implemented are detailed in the following paragraphs.

9.1. Under Voltage Protection (UVP)

LED1 - Flash Red (every 5 seconds), LED2 - Off

This mode protects the battery from reaching a low voltage level that can damage the battery as described in the paragraph 7.9.

9.2. Over Voltage Protection (OVP)

LED1 - Flash Green (every 5 seconds), LED2 - Off

This mode protects the battery from reaching a high voltage level that can damage the battery. If any of the battery cells voltage increases above 3.65V for four (4) seconds, the battery will go into OVP protection mode. The battery will automatically reconnect if discharged or when the highest cell voltage is <3.6V. Refer to 4.2.1 for specific thresholds.

9.3. Under Temperature Protection (UTP)

LED1 - Flash Green (1 second), LED2 - Flash Red (1 second)

This mode protects the battery from being charged in temperatures below freezing, which can damage the battery. The BMS will not allow charge current when the battery temperature is below freezing (0°C/-32°F) or (-20°C/-4°F) for any Low Temperature (LT) version. However, the BMS will allow discharge below freezing down to -20°C/-4°F.

9.4. Over Temperature Protection (OTP)

LED1 - Flash Green (every 1 second), LED2 - Flash Red (every 1 second)

This mode protects the battery from reaching high temperatures, which can damage the battery.

- **Charge OTP** - The BMS will disconnect while charging when the battery temperature exceeds 55°C/131°F.
- **Discharge OTP** - The BMS will disconnect while discharging when the battery temperature exceeds 55°C/131°F.

9.5. Over Current Protection (OCP)

LED 1 - Solid Green, LED 2 - Solid Yellow

The BMS will allow over discharge current and over charge current for limited time in order to allow peak power and transient energy requests, but it will protect the battery with a time of intervention reduced while the level of the peak current increase. Refer to the Battery Discharge Specification table 4.2.2 and the Battery Charge Specification table 4.2.1.

The protection is settled with two thresholds with different time of intervention depending on the value of the max current and persistency. Both the protection will automatically recover and reset allowing the battery to resume the normal operation after 30 seconds. This self-recovery will be disabled after 5 consecutive times and then a manual operation with the Push Button will be necessary to reset the protection.

9.6. Short Circuit Protection (SCP)

LED1 – Solid Green, LED2 – Solid Yellow

This mode protects the battery from discharging at extremely high levels of current. The short circuit current level for a single battery is listed in the Discharge Specification in 6.2.2.

10. CANBUS COMMUNICATION

This section provides the basics for CANbus operation and/or integration. For additional details on how to interface to the CANbus and interpret the messages consult the RELiON CANbus Specification Document. Parallel connected InSight batteries communicate internally via CANbus. External communication is available through the CANbus OUT port of the battery. The 12V battery is RV-C compatible (at OEM request) for up to 10 batteries through bridge.

10.1. CAN Battery Connectors: M8-5P

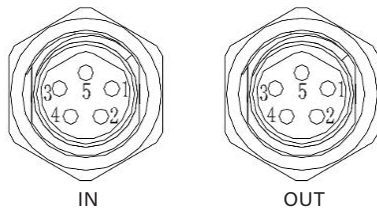

PIN	CAN INPUT BATTERY CONNECTOR (Next to Negative Terminal)	CAN OUTPUT BATTERY CONNECTOR (Next to Postive Terminal)
1	Reserve	Reserve
2	CANbus Address IN	CANbus Address IN
3	CAN-L	CAN-L
4	CAN-H	CAN-H
5	P- (Battery Negative)	P- (Battery Negative)*

**In the standard CANbus cables P- shall not be connected. Reach out the technical support for specific needs.*

10.2. Communication Hardware

The batteries do not have 120Ω termination resistors, but it is highly recommended for the stability of the communication. Dedicated terminator is available among the RELiON battery accessories from the website www.relionbattery.com.

Up to ten batteries may be read in a single CANbus network.

10.3. CANbus Details

- CAN2.0A
- Identifier: 11-bit
- Broadcast ID: 0x5FF
- Bit Rate: 250kbps
- Multi-Byte value form: Little-Endian

10.4. Broadcast Data

The BMS broadcasts alarms, system status, and SOC every 3 seconds via ID 0x5FF. If an alarm is triggered it will be broadcasted immediately.

Broadcast Data Frame

ID	DLC	D0	D1	D2
0x5FF	8	0x20	0x81	0x21
D3	D4	D5	D6	D7
0X01	Alarm1	Alarm2	Status	SOC

11. CHARGING GUIDELINES

Follow these charging guidelines to achieve optimal performance and maximum life from your RELiON Lithium Iron Phosphate (LiFePO₄) InSight battery.

Please read and exercise the charging practices below to achieve the best results.

11.1. Charger Inspection

Check that your charger's cables are insulated and free of breakage. Charger terminal connectors should be clean and properly mate with the battery terminals to ensure a good connection and optimum conductivity.

11.2. Charge Temperature

LiFePO₄ batteries can be safely charged between 0°C to 55°C (32°F to 131°F). Extended range is available for the Low Temperature (LT) product version -20°C to 55°C (-4°F to 131°F).

LiFePO₄ batteries do not require temperature compensation for voltage when charging at hot or cold temperatures.

The InSight Series batteries come with a BMS that protects the battery from over-temperature. If the BMS disconnects due to high temperature, wait until the temperature reduces before using or charging the battery. Please refer to your specific battery's Data Sheet for the BMS high temperature cut-off and reconnect values.

11.3. Prior to Charge

It is best to use/select a Lithium charge profile if available in order to maximize performance and lifespan of the battery. Consult your manual or charger manufacturer for directions on this capability. Some charger models only have the stock charge profile available.

If the charger is not capable of Lithium battery charging profile, then it is best to select GEL or AGM charge profile in that order of availability. Consult your manual or charger manufacturer for directions on this capability.

Spot check the battery SOC LED indicators with a quick press and release of the battery Power Button. See the table in 9.5.2 to determine the SOC.

Specific Charging parameters can be derived from the table in section 4.2.1.

11.4. During Charge

Check if charge current is being supplied in one of the following ways:

- Battery LED indicators: The proper LED sequence be displayed: LED1 – Off, LED2 – flashing green (every 2 seconds).
- RELiON Battery Display Indicator (BDI): Spot check the accessory gauge to see if charge current is flowing and battery SOC percentage increasing.
- Digital Voltmeter w/amp clamp (DVM): Spot check the accessory gauge to see if charge current is properly flowing.

11.5. Charge Completion

The charger’s behavior at the end of a Lithium battery recharge may vary from the standard operation consistent with charging lead-acid batteries.

Chargers typically display a solid Green Light when the charge is completed, and a flashing green light when the battery is near the end of charge (will vary by charger). Both conditions may or may not occur depending on your charger design. Neither condition is necessarily required to properly achieve a full recharge.

Lithium batteries may temporarily disconnect their voltage as they reach a full charge, before the charger is complete. This may cause the charger to repeat its charge initiation sequence when this occurs (various lights and noises may occur during this sequence). This is acceptable and will not harm the battery. Simply unplug or disconnect the charger, if this occurs, and the battery voltage will return.

Check to see if a full charge was completed in one of the following ways:

Battery LED indicators: Spot check the battery LED’s with a quick press and release of the battery Power Button. See the table in Section 10 to determine the SOC.

RELiON Battery Display Indicator (BDI): Spot check the accessory gauge to see if battery SOC percentage reached 100%.

12. BATTERY INDICATOR

If you are using a voltage-based fuel gauge that is designed for lead-acid batteries it will not accurately provide state of charge (SOC). Please replace your fuel gauge with one that measures current rather than voltage. The BMS in the battery provides the SOC of the battery via CAN. Refer to the RELiON Battery CAN bus Specification Document for details.

RELiON offers optimized products to support the best integration and use of the batteries, such as:

PART NUMBER	PRODUCT NAME
BI-3140R-12	InSight 12V Fuel Gauge
BI-3140R-2448	InSight 24V and 48V Fuel Gauge
WIRE BI-3140-03	InSight Fuel Gauge Wire Harness w/3 Meter Cable (6 and 9 mt length available)
RS-GC2-03	InSight Remote Power Switch w/3 Meter Cable (6 and 9 mt length available)

More accessories are available on the website www.relionbattery.com.

13. BATTERY STORAGE

TEMPERATURE AND HUMIDITY	DURATION
10°C to 25°C (50°F to 95°F) and 15% to 90% RH	Up to 12 months - Upon Charging every 5-6 months

14. RECYCLING

Terminals must be covered with a protective cap or non-conductive tape or glue prior to battery disposal to lithium recycler. Dispose of LiFePO₄ batteries at an authorized lithium recycling facility.

15. RELION AND NAVICO GROUP TECHNICAL SUPPORT

If you have any technical questions, please contact at

USA and AMERICAs

+1 803-547-7288 • TOLL FREE: (855) 931-2466 | N85W12545 Westbrook Crossing - Menomonee Falls, Wisconsin 53051, USA

EMEA

+31 (0) 20 34 34 22 100 | Snijdersbergweg 93 1105 AN - Amsterdam, The Netherlands

APAC

+64 9 415 72 61 | 40-42 Apollo Drive - Albany, Auckland 0632, New Zealand

Or through the website www.relionbattery.com

