



LITHIUM IRON PHOSPHATE BATTERY

ELECTRICAL SPECIFICATIONS

Nominal Voltage	12.8 V
Nominal Capacity	300 Ah
Capacity @ 25A	720 min
Energy	3840 Wh
Resistance	≤30 mΩ @ 50% SOC
Efficiency	99%
Self Discharge	<3% per Month
Maximum Modules in Series	1 (Single Use)

DISCHARGE SPECIFICATIONS

Maximum Continuous Discharge Current	100 A
Peak Discharge Current	800 A (2 s)
BMS Discharge Current Cut-Off	1000 A ±100 A (2.2 ±1 ms)
Recommended Low Voltage Disconnect	11 V
BMS Discharge Voltage Cut-Off	9.2 V (2.3 ±0.08 vpc) (4.2 ±0.5 s)
Reconnect Voltage	10 V (2.5 ±0.1 vpc)
Short Circuit Protection	200-600 μs

TEMPERATURE SPECIFICATIONS

Discharge Temperature	-4 to 140 °F (-20 to 60 °C)
Charge Temperature	32 to 113 °F (0 to 45 °C)
Storage Temperature	23 to 95 °F (-5 to 35 °C)
BMS High Temperature Cut-Off	176 °F (80 °C)
Reconnect Temperature	122 °F (50 °C)

DIMENSIONAL SPECIFICATIONS

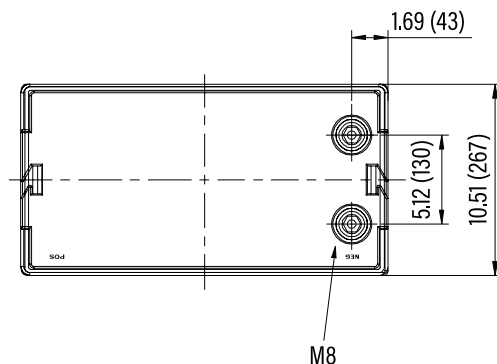

MECHANICAL SPECIFICATIONS

Dimensions (L x W x H)	20.5 x 10.5 x 9.0"
	520 x 267 x 228 mm
Weight	83 lbs (37.5 kg)
Terminal Type	M8
Terminal Torque	80 - 100 in-lbs (9 - 11 N-m)
Case Material	ABS
Enclosure Protection	IP56
Cell Type - Chemistry	Cylindrical - LiFePO ₄

CHARGE SPECIFICATIONS

Recommended Charge Current	50 A
Maximum Charge Current	100 A
Recommended Charge Voltage	14.2 V - 14.6 V
BMS Charge Voltage Cut-Off	15.4 V (3.85 ±0.025 vpc) (1 ±0.2 s)
Reconnect Voltage	14.6 V (3.65 ±0.05 vpc)
Balancing Voltage	14.4 V (3.6 ±0.025 vpc)

COMPLIANCE SPECIFICATIONS

Certifications	CE (battery) UL1642 & IEC62133 (cells)
Shipping Classification	UN 3480, CLASS 9

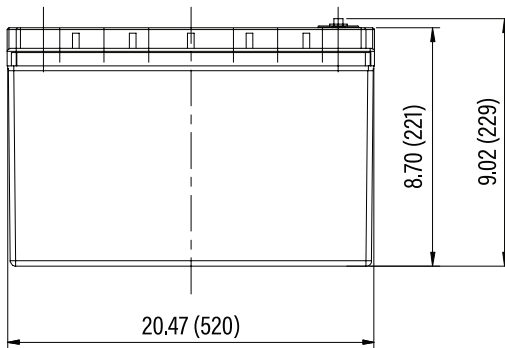



PERFORMANCE CHARACTERISTICS

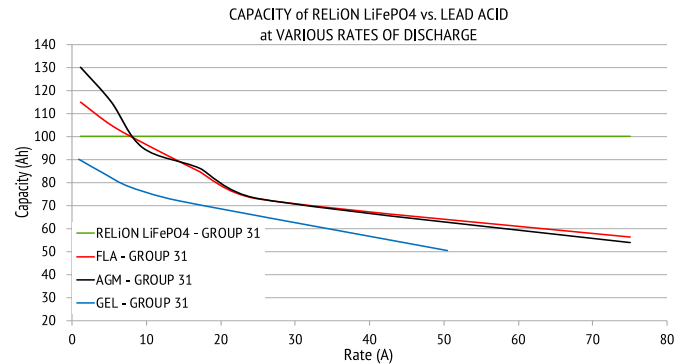
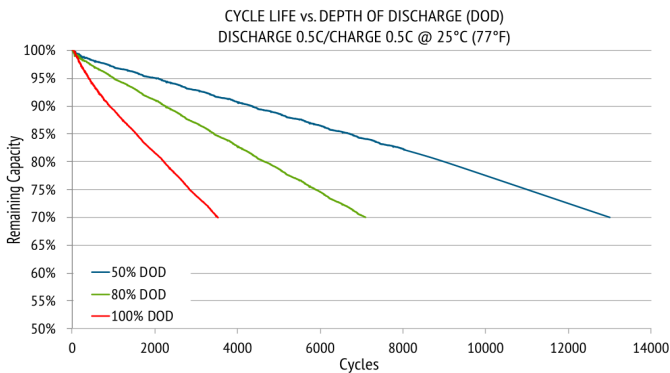
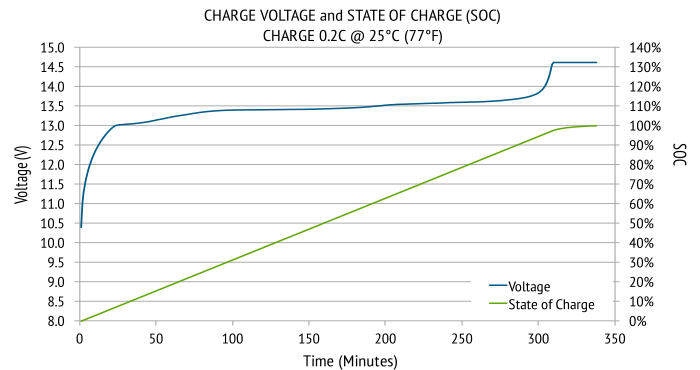
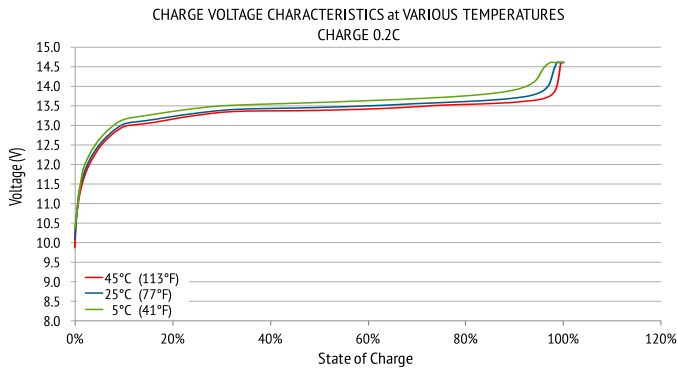
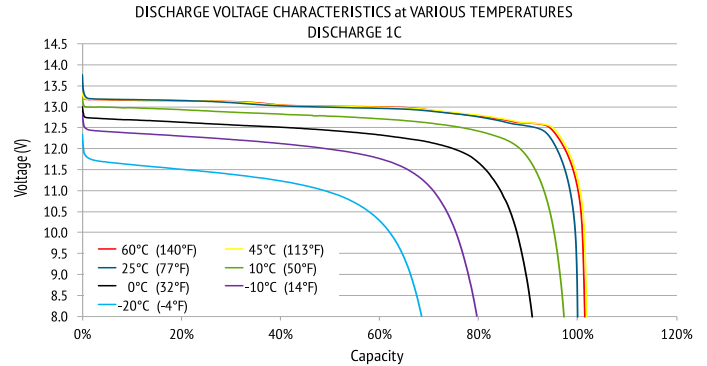
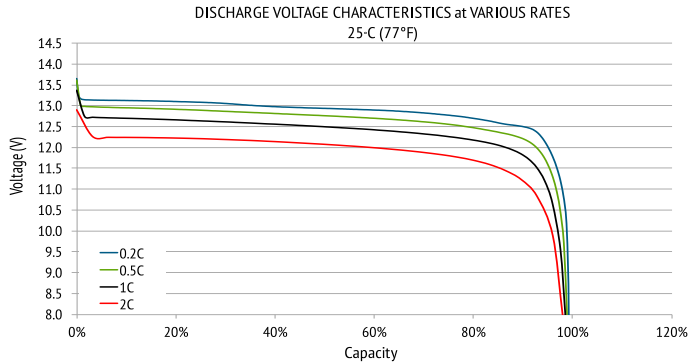

RB300DS0714-2018

