



LITHIUM IRON PHOSPHATE BATTERY

ELECTRICAL SPECIFICATIONS

Nominal Voltage	51.2 V
Nominal Capacity	25 Ah
Capacity @ 5A	300 min
Energy	1280 Wh
Resistance	≤70 mΩ @ 50% SOC
Efficiency	99%
Self Discharge	<3% per Month
Maximum Modules in Series	1 (Single Use)

DISCHARGE SPECIFICATIONS

Maximum Continuous Discharge Current	20 A
Peak Discharge Current	25 A (4 ±1 s)
BMS Discharge Current Cut-Off	60 A ±10 A (6 ±3 ms)
Recommended Low Voltage Disconnect	44 V
BMS Discharge Voltage Cut-Off	40 V (2.5 ±0.1 vpc) (100 ±50 ms)
Reconnect Voltage	32 V (2.0 ±0.1 vpc)
Short Circuit Protection	400-600 μs

TEMPERATURE SPECIFICATIONS

Discharge Temperature	-4 to 140 °F (-20 to 60 °C)
Charge Temperature	-4 to 113 °F (-20 to 45 °C)
Storage Temperature	23 to 95 °F (-5 to 35 °C)
BMS High Temperature Cut-Off	149 °F (65 °C)
Reconnect Temperature	122 °F (50 °C)

*Refer to charge currents below 32°F (0°C)

DIMENSIONAL SPECIFICATIONS

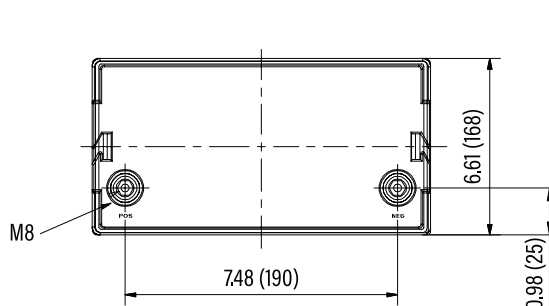

MECHANICAL SPECIFICATIONS

Dimensions (L x W x H)	10.2 x 6.6 x 8.6"
	260 x 168 x 218 mm
Weight	27.6 lbs (12.5 kg)
Terminal Type	M8
Terminal Torque	80 - 100 in-lbs (9 - 11 N-m)
Case Material	ABS
Enclosure Protection	IP56
Cell Type - Chemistry	Cylindrical - LiFePO ₄

CHARGE SPECIFICATIONS

Recommended Charge Current	1.25 A - 12.5 A
Maximum Charge Current	20 A
Charge Current 14 to 32 °F (-10 to 0 °C)	≤0.1 C
Charge Current -4 to 14 °F (-20 to -10 °C)	≤0.05 C
Recommended Charge Voltage	56.0 V - 58.4 V
BMS Charge Voltage Cut-Off	60.8 V (3.8 ±0.05 vpc) (1.0 ±0.5 s)
Reconnect Voltage	57.6 V (3.6 ±0.05 vpc)
Balancing Voltage	57.6 V (3.6 ±0.025 vpc)

COMPLIANCE SPECIFICATIONS

Certifications	CE (battery) UL1642 & IEC62133 (cells)
Shipping Classification	UN 3480, CLASS 9

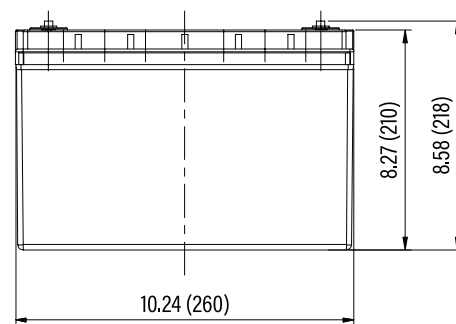



PERFORMANCE CHARACTERISTICS

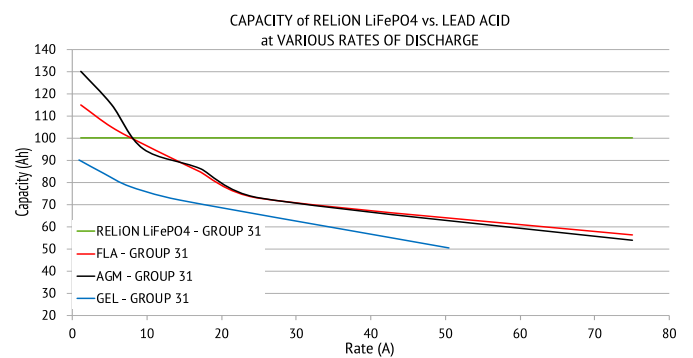
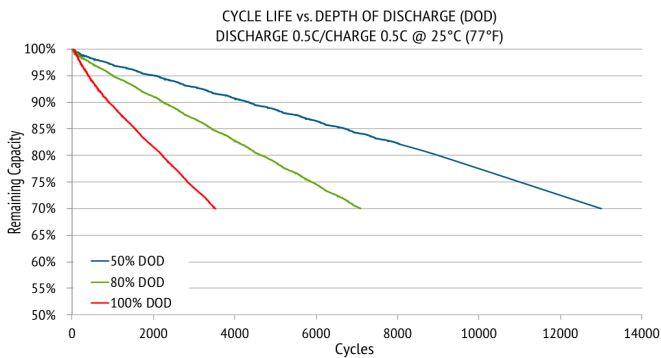
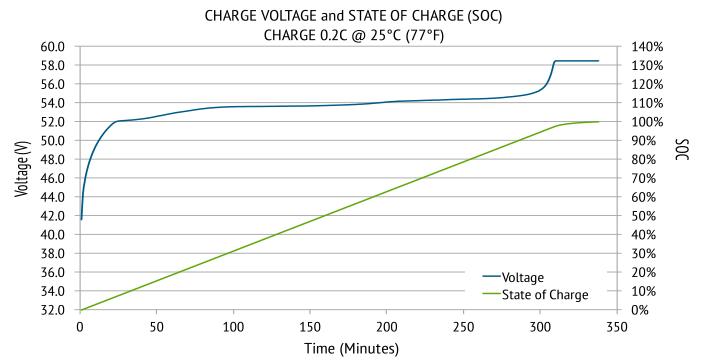
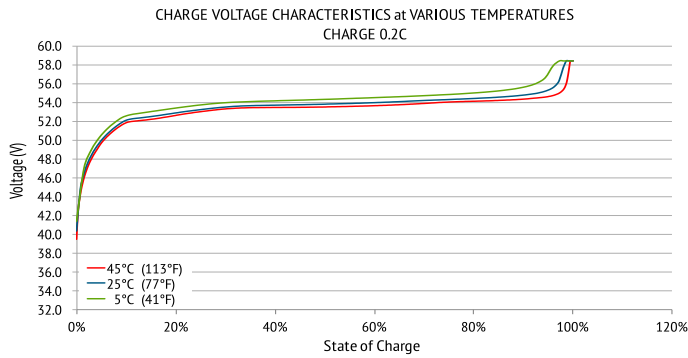
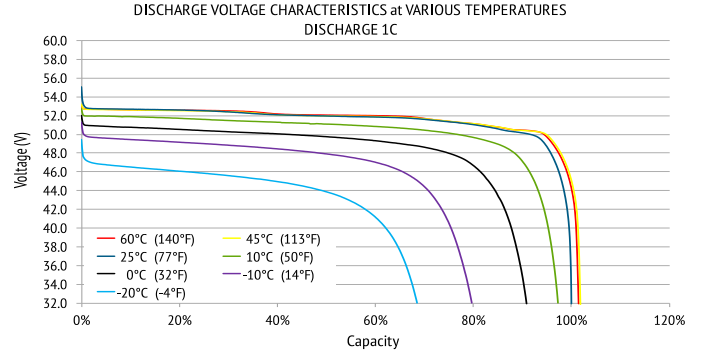
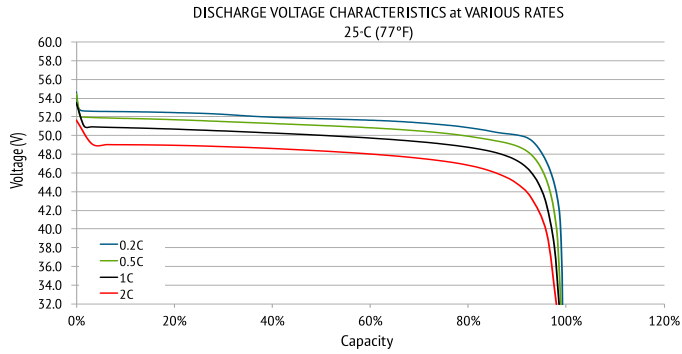

RB48V25DS09.20.2019

